

## Technical description

### Dimensions:

#### Vertical post

50x50, cut to length and predrilled for the passage of the intermediate rail.

#### Ergonomic handrail

Length 6 m (at 1100 mm from ground).  
(50x5 flat profile for bending)

#### Intermediate rail

Ø 26 length 6 m (at 625 mm from ground).  
(50x5 flat profile for bending)

#### Kick plate (Type A)

150x15, length 6 m (at 5 mm from ground).

### Weight:

Type "A" guardrail: 6 kg/m

### Resin:

Polyester isophthalic, yellow safety.

### Chemical resistance:

Consult the chemical resistance chart for compatibility.

### Norms:

"A" Type guardrail is in accordance with ISO 14122 and is certified by the Italian U.S.S.L.

### Assembling:

#### Simple and safe:

Clean the surface, drill and assemble with rivets, eventually reinforce with glue. The bases must be fixed with bolts.

#### Suggested glue:

Use a 2 component epoxy glue or eventually cyanoacrilic if the chemical aggression is not excessive.

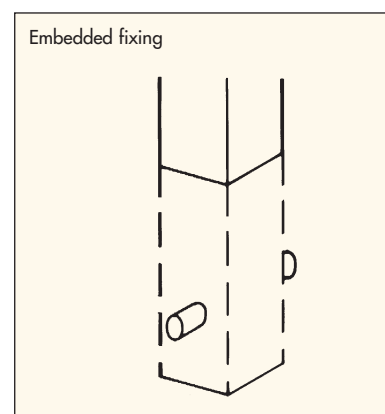
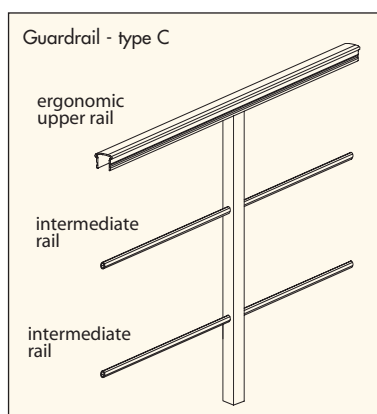
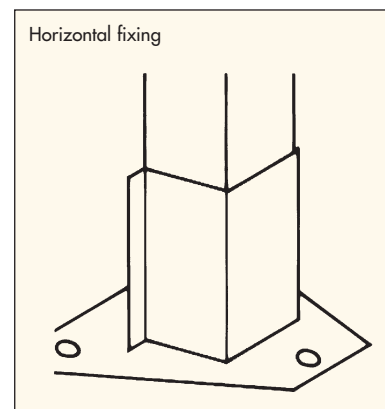
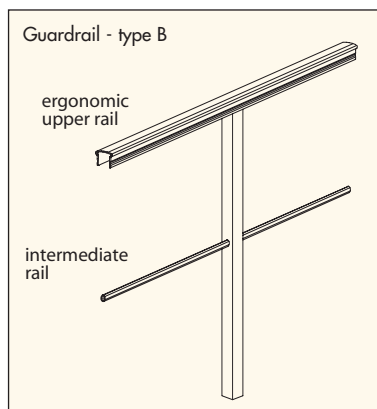
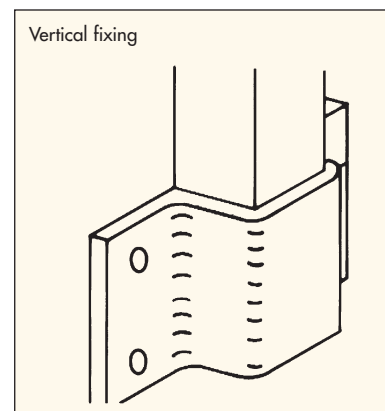
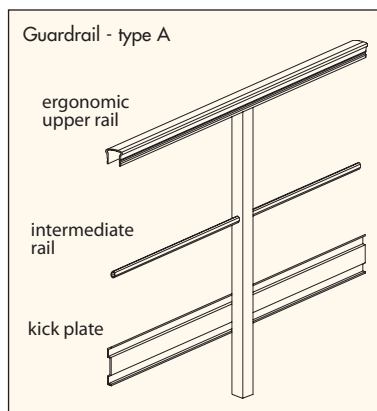

We reserve the right to modify without notice our production properties and the written data on this document.

## Which type to choose?

### Posts and bases:

#### Vertical fixing:

vertical post: P-0500121010 or P-0500131010  
(length 1200) (length 1250)

base: A-BASE011010

When fixing the guardrail to a polyester beam, we suggest using a backplate (A-PIAS101010).

#### Horizontal fixing:

vertical post: P-0500111010 (length 1100)

base: A-BASE02A4TG or A-BASE03A4TG

#### Embedded fixing:

vertical post: P-0500121010 or P-0500131010

### Ergonomic upper rail

U-0750601010 (length 6 m)

### Intermediate rail

T-0260601010 (length 6 m)

(50x5 flat profile for bending - length 6 m)

### Kick plate

B-1500601010 (length 6 m)

### Fixing by means of:

#### a) Pin (to be used with glue)

T-0050201030 (length 1 m)

#### b) Glue

Approx. 20 grams of glue for 25 metres of guardrail.

#### c) Stainless steel rivets

### 90° connection elements

#### For the handrail

A-CONN011010 (1 piece for connection).

#### For the intermediate rail

A-CONN021010 (1 piece for connection).

#### For the kick plate

A-CONN031010 (1 piece for connection).

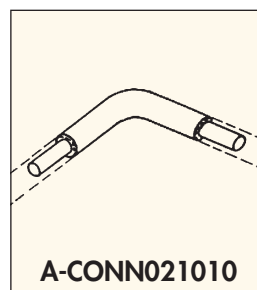
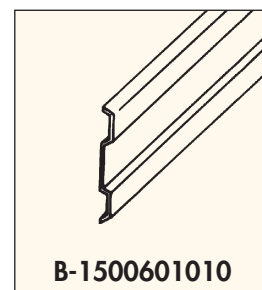
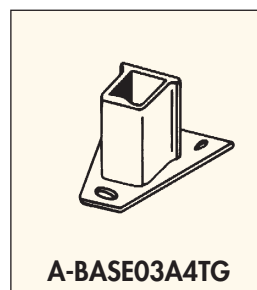
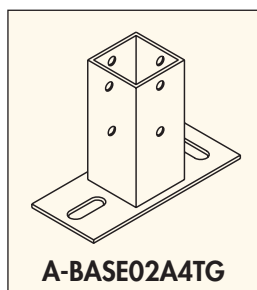
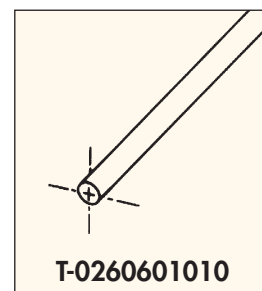
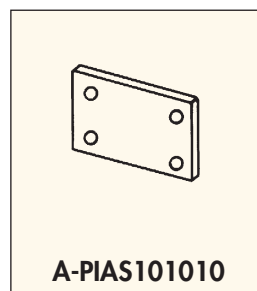
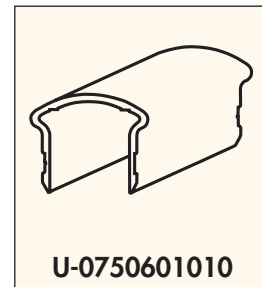
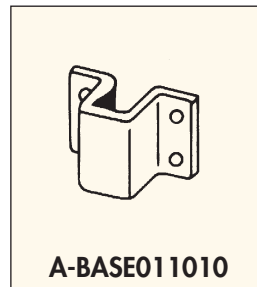
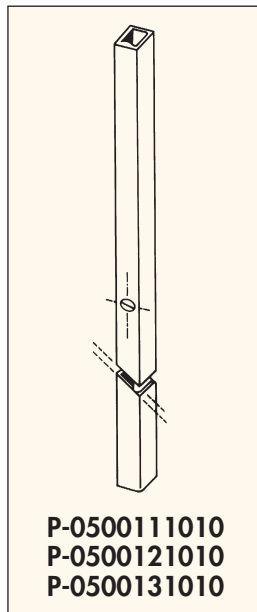

Our products are guaranteed one year within a normal use.

We reserve the right to modify without notice our production properties and the written data on this document.